

3.1

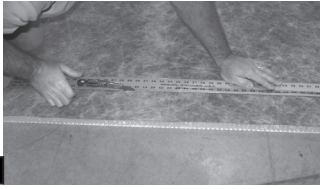

3.2



3.3



3.4

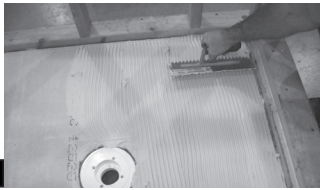

3.6

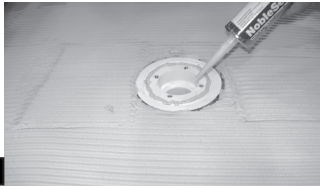

3.7

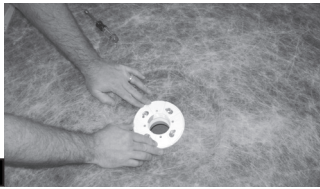

3.9



4.1c



4.1d

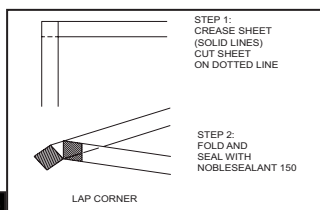

4.1e

1. PRODUCT

1.1 ProBase: is a composite shower base made from high-strength polypropylene with Noble sheet membrane laminated to the top. ProBase is sloped 1/4" per foot from the perimeter to the drain. The drain area is depressed to allow the Noble sheet membrane to be clamped into most standard clamping-ring drains. Additional Noble products included with ProBase are: Inside Corners (4 qty), Outside/Dam Corners (4 qty), 14" x 17" of ValueSeal® membrane for flashing at the perimeter, NobleSealant 150, and a Positive Weep Protector™.

1.2 Tools needed: standard tools including utility knife with linoleum blade or fine-tooth saw to cut ProBase, heavy-duty caulking gun, and 1/4" x 3/8" square-notched trowel.

1.3 For applications not detailed herein, contact Noble Company.

2. PREPARATORY WORK

2.1 Read these instructions completely for installation options.

2.2 Substrate must be clean, flat, level, and solid (no holes, valleys, or high spots), meet building code requirements, and be suitable for application of modified thin-set.

2.3 Drain body must be flush (in plane) with substrate. If not, use tile backer board or suitable material to make it flush.

2.4 Curb or curb structure should be installed prior to ProBase. See curb details and plan accordingly.

2.5 Backer board can be installed before or after ProBase and curb. Plan accordingly, as the sequence will affect installation.

3. PROCEDURE

3.1 Measure the shower floor from center of drain to each wall.

3.2 Mark and cut ProBase to size. Slightly smaller is desirable (1/8" gap around perimeter).

3.3 Place ProBase in shower and dry fit. ProBase must lay flat.

3.4 Cut slits in membrane for clamping ring bolts and cut drain hole.

3.5 Remove ProBase.

3.6 Trowel a modified thin-set using 1/4" x 3/8" x 1/4" square-notched trowel over the substrate. Comb thin-set in parallel lines.

3.7 Apply a continuous bead (no skips) of NobleSealant 150 on the lower drain body outside of the clamping-ring bolts. Place ProBase in shower. Embed the membrane over the NobleSealant 150 to flatten the bead.

3.8 Embed ProBase into thin-set using firm foot pressure. Check to ensure there is 100% coverage (on base and subfloor) and no voids. Add thin-set if necessary.

3.8 a Apply weight to surface of ProBase until thin-set has cured.

3.9 Orient clamping ring in low position. Bolt clamping ring to drain body.

4. FLASHING WALLS

Flashing membrane can be installed behind or in front of tile backer board.

4.1 Flashing behind backer board - Option 1

a. Fold the 14" x 17" ValueSeal flashing membrane lengthwise approximately 2" and crease. The 2" will overlap ProBase leaving approximately 12" to turn up vertical walls. See Flashing Detail A on backside.

b. Measure length of each wall.

c. Mark flashing membrane for each wall and cut 2" to the crease. See Picture 4.1c.

d. Overlap flashing (2") on ProBase, mark, and apply sealant as described below:

NobleSealant 150: Apply a continuous bead to bottom sheet per manufacturer's instructions.

Modified Thin-Set: Apply a uniform layer to bottom sheet. Overlap sheet and flatten membrane with roller (recommended) or with flat edge of trowel or float.

Note: You should see sealant at the seam.

e. Use lap corners and seal overlaps with NobleSealant 150. See Picture 4.1d.

f. Install preformed inside corners over center of lap corners. Seal with NobleSealant 150.

g. Install preformed dam corners on the inside and outside of the curb (dam). Seal with NobleSealant 150.

h. Cut flashing to wrap over the curb.

i. Fold flashing over curb. See Detail B or C on backside.

j. Adhere membrane to all three curb surfaces with modified thin-set.

Note: Curb overlays and solid curbs are available from Noble Company.

k. Mechanically fasten upper edge of membrane (top 2") to solid backing or studs.

l. Install backer board per manufacturer's installation instructions and industry guidelines. No penetrations in the membrane less than 2" above the finished dam height.

4.2 Flashing on front side of backer board - Option 2

a. Follow steps 4.1a through 4.1j.

b. Bond flashing to front side of backer board using either NobleBond EXT or modified thin-set.

Note: Thin-bed waterproofing membrane (e.g., NobleSeal® TS or ValueSeal) should be sealed over flashing and installed to the height of the tile installation. See waterproofing sheet membrane installation instructions.



5. FLOOD TEST & WATERPROOFING

- 5.1 Allow assembly to cure for 20 hours.
- 5.2 Plug drain; fill pan with water.
- 5.3 Flood test following plumbing code requirements (generally 24 hours).
- 5.4 Check for leaks and make necessary repairs.

6. COMPLETING THE SLOPE

- 6.1 Install strainer.
- 6.2 Install weep protector on strainer.
- 6.3 Fill depression around drain with mortar (not modified thin-set) to required plane to match desired tile height.

NOTE: Follow appropriate industry standards and local plumbing codes.

- 6.4 Adjust strainer to desired tile height.
- 6.5 Let mortar cure before tiling.

6.6 PROTECTION OF SHEET: If not covered by wearing surface, protect the installed sheet from damage and all foot traffic (use mortar skim coat, rugs, plywood, etc.).

7. TILE INSTALLATION

- 7.1 Tile using modified thin-set following industry guidelines. If tiling with 2" x 2" or smaller tiles, use epoxy grout.

8. FIGURES / DRAWINGS: (Not to Scale)

A FLASHING DETAIL

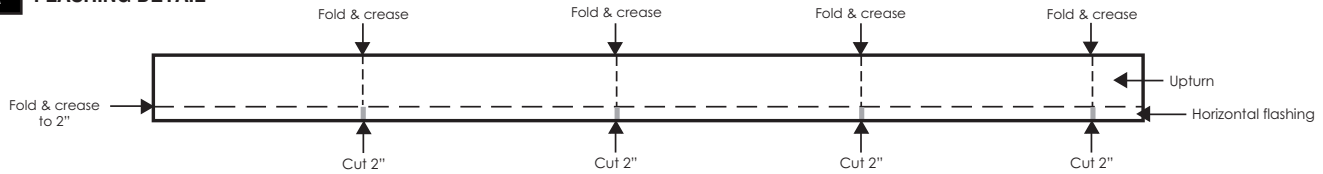

B SOLID CURB

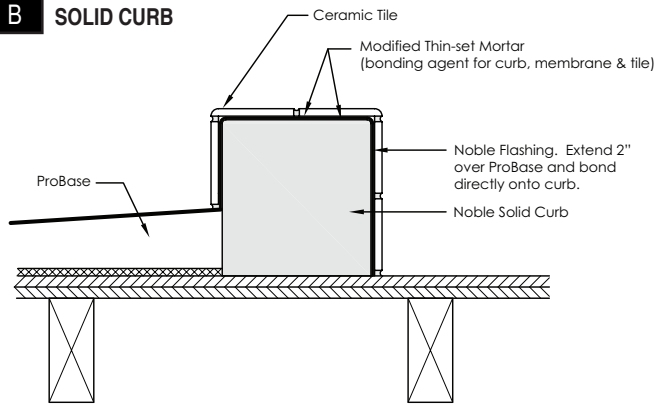

C CURB OVERLAY

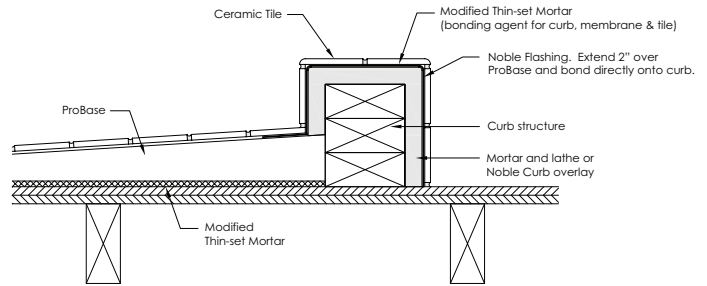

D PROBASE AND SOLID CURB IN SHOWER

