

# ProBase® II

## Single-Slope Shower Base and Kit

### Installation Instructions

www.noblecompany.com



Patents Pending

#### CONTENTS

1. General Information .....	1	11. Install ValueSeal to Curb.....	6
2. Materials.....	1	12. Install Thin-Line Outside Corners.....	6
3. Planning .....	2	13. Protection of Sheet.....	7
4. Preparation.....	3	14. Install ValueSeal on Walls.....	7
5. Layout .....	3	15. Install Pipe Collar .....	7
6. Install Base and Shims.....	4	16. Install Mixing Valve Collar .....	7
7. Install Curbs .....	5	17. Flood Testing .....	8
8. Install ValueSeal® on Base.....	5	18. FreeStyle Linear Drain™ Installation ..	8
9. Secure ValueSeal to Drain.....	5	19. Cleaning Drain .....	8
10. Install Thin-Line™ Inside Corners.....	6	20. Limitations .....	8

#### 1. GENERAL INFORMATION:

ProBase II is a composite shower base made from expanded polystyrene and honeycomb construction with fiber laminated to the top. ProBase II is sloped 1/4" per foot to the drain.

**1.1 RECOMMENDED TOOLS:** Tape measure, utility knife, caulking gun, straight edge, small floor roller, margin trowel, 1/8" x 1/8" or 1/4" x 1/4" v-notched trowel and 1/4" x 3/8" x 1/4" square-notched trowel, appropriate plastic pipe primer, and cement.

#### 2. MATERIALS:

**Single-Slope Base**

**Shims**

**ValueSeal Waterproofing**

**Solid Curb**

**Thin-Line Inside Corners**

**Thin-Line Outside Corners**

**Thin-Line Pipe Collar**

**Thin-Line Mixing Valve Collar**

**NobleSealant**

**FreeStyle Linear Drain**

#### 32" x 60" Base Kit

2-piece construction

2 pieces included

1 Roll

2-30" Solid Curbs

4

4

1

1

1 tube

1 PVC or ABS drain with strainer

24" or 32" length

#### 64" x 64" Base w/ Accessory Kit

4-piece construction

3 pieces included

1 Roll, plus a 6" wide sheet for shower pan

1-72" Solid Curb

4

4

1

1

1 tube

1 PVC or ABS drain with strainer

32", 36", 40", 48", 54", or 60" length

Included with all FreeStyle Linear Drains:

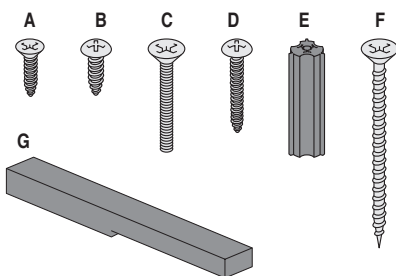

- A) Clamping Collar Screw:  
#6 5/8" Phillips Flat Head
- B) Pre-Strainer Screw:  
#8 1/2" Phillips Pan Head
- C) Strainer Height Adjustment Screw:  
#10 1-1/4" Phillips Flat Head
- D) Strainer to Base Screw:  
#6 1" Phillips Pan Head
- E) Drain Base to Sub-Floor Concrete  
Anchor: 1" Long 1/4" Hole
- F) Drain Base to Sub-Floor Screw:  
#8 2-1/2" Phillips Course Thread
- G) Strainer Height Adjustment Tool

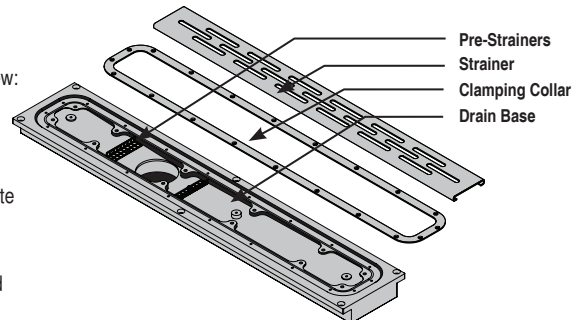

VIEW MORE PRODUCT  
DETAILS, VIDEOS,  
AND DIAGRAMS ONLINE



3. PLANNING:

3.1 BASE, CURBS, AND SHEET BOND COAT

3.1.a MODIFIED THIN-SET (Preferred): See manufacturer's coverage rate.

3.1.a.1 Hot and Cold Weather Procedure: Consult bond coat manufacturer for safe high-and low-temperature limits and cure times. Noble Company sheet membranes remain flexible to -25°F.

3.2 NOBLESEALANT (Waterproofing Only): A 10.3 oz tube of NobleSealant seams approximately 40 linear feet.

**GENERAL NOTES REGARDING THE USE OF MODIFIED THIN-SET:**

- a. Use modified thin-set cement mortar in compliance with ANSI A118.4 (or greater).
  - b. Mix modified thin-set per manufacturer's instructions.
  - c. Spread modified thin-set with appropriate trowel to achieve complete coverage.
  - d. Trowel an area as wide and as deep as can be comfortably reached. To avoid trapping air, trowel modified thin-set in parallel rows across the width or length.
  - e. Variation in trowel size, angle at which trowel is held, mixing ratio, or any combination thereof may be necessary to achieve full coverage.
  - f. All ridges of bond coat must be parallel to allow the air to escape when embedding.
  - g. Embed into bonding agent before it begins to form "skin".
  - h. Embed into bond coat by working from center, outwards.
  - i. Embed using foot pressure (base only), rubber hand roller, flat side of trowel, or float (for small areas).
- CAUTION:** Be careful not to puncture membrane with corner of trowel.
- j. Allow adequate time for curing: typically 24 hours.

**FIGURE 1: TYPICAL LAYOUT**

(For larger installations using 64" x 64" base, this typical layout will include 4 base pieces and 2 pieces of shim B.)

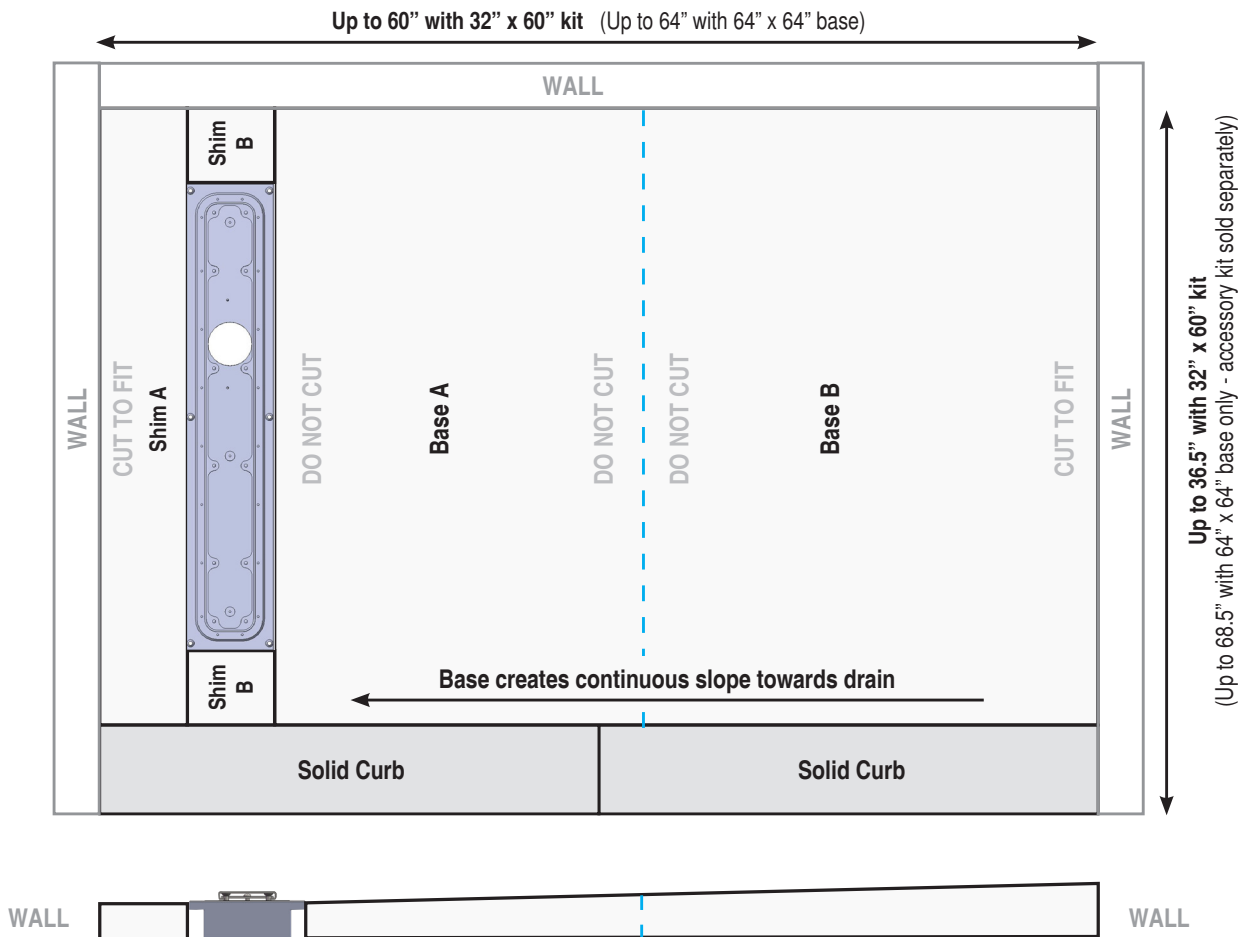

#### 4. PREPARATION:

Read these instructions completely prior to installation. Test materials and method under job-site conditions to confirm suitability.

**4.1 INSPECTION:** Substrate must meet requirements set forth by the TCNA and ANSI A108 and A118 standards. Report in writing any deficiencies that might affect performance of the system.

**4.2 PROCEDURE:** Install ProBase II Single-Slope Shower Kit.

**4.3 SUBSTRATES:** Backer board should be installed prior to the shower kit. Substrate condition for base is the same as tile (see TCNA guidelines). Slabs on, above, or below grade should be tested for moisture content and pH. Slabs must be flat and level. Floor preparation (i.e., leveling, patching) should be done prior to installation of base.

**4.3.a DEPRESSIONS:** Floors with depressions may cause base to span over these depressions. Fill the depression prior to installation of base. Follow appropriate industry guidelines.

**4.4 INSTALLER:** Installer should be familiar with Noble Company's current written instructions, TCNA Handbook recommendations, and ANSI A108 and A118 standards. Contractor should have knowledge of Noble Company products and installation procedures.

#### 5. LAYOUT:

**5.1 CURBS:** Measure the entire shower area and determine the location of the curbs. Set one curb in desired location and measure from the end to the wall for the second curb. Mark and cut second curb to measurements and dry fit. Mark the location of the curbs on the sub-floor. Set aside.



#### 5.2 FREESTYLE LINEAR DRAIN:

**NOTE:** Confirm proper plastic pipe primer and cement for drain base type (PVC or ABS). Check drain label to confirm.

**5.2.a WASTE PIPE NOT INSTALLED:** Place drain base in desired location on sub-floor. Mark the waste pipe location on the sub-floor. Cut the opening in the sub-floor.

**5.2.a.1: INSTALL WASTE PIPE:** Follow local plumbing codes to properly install and secure 2" ID waste pipe 3/4" above the sub-floor.

**NOTE:** Waste pipe may be installed after fastening the drain base to the sub-floor if it is accessible from below.



## 5.2.b WASTE PIPE INSTALLED:

**5.2.b.1 FOR CONCRETE SUB-FLOOR:** Dry fit the drain base over the location of the existing waste pipe. Mark all holes in outside flange of the drain base onto the concrete floor. Remove the drain base and drill 1/4" holes, 1-1/2" deep where marked. Drive plastic anchors flush in all holes. Apply appropriate plastic pipe primer and cement to drain body and waste pipe following local plumbing codes and manufacturer's instructions. Fit and fully seat the drain base onto the waste pipe. Fasten drain base to sub-floor by screwing 2-1/2" deck screws through all holes in the outside flange of the drain base into the plastic anchors. **Do not over tighten.**

**5.2.b.2 FOR WOOD SUB-FLOOR ONLY:** Dry fit the drain base over the location of the existing waste pipe. Apply appropriate plastic pipe primer and cement to drain body and waste pipe following local plumbing codes and manufacturer's instructions. Fit and fully seat the drain base onto the waste pipe. Fasten drain base to sub-floor by screwing 2-1/2" deck screws through all holes in the outside flange of the drain base. **Do not over tighten.**

## 5.3 BASE: Refer to Figure 1.

**5.3.a BASE A:** Measure the inside edge of the marked curb to the wall. Cut base piece A to the measured width and dry fit. (2 Base A pieces are included with the 64" x 64" option.)

**5.3.b BASE B:** Set base piece A in place at drain. Measure the back edge of piece A to the back wall. Cut base piece B to the appropriate length and width, allowing a 1/8" gap between base piece B and the wall. (2 Base B pieces are included with the 64" x 64" option.)

**5.3.c. SHIMS:** Cut long shim A to desired width and length. Cut one B shim to fill gap between the drain base and the curb, and another to fill between the drain base and the wall. Small shims are sized to match the width of the drain. Dry fit all base and shim pieces making sure they lay flat and do not bind.

**NOTE:** If drain length is equal to width of shower, then B shims will not be necessary.



## 6. INSTALL BASE AND SHIMS:

**6.1 INSTALL BASE:** Apply modified thin-set using a 1/4" x 3/8" x 1/4" square-notched trowel over the substrate and upturns. Key-in modified thin-set to the bottom and ends of the bases. Embed bases into the modified thin-set with slope towards drain using firm foot pressure to ensure 100% coverage and no voids.

**NOTE:** Check that base is flush with drain.

**6.2 INSTALL SHIMS:** Key-in modified thin set to the bottom and edges of the shims. Embed shims into the modified thin-set to ensure 100% coverage and no voids.



## 7. INSTALL CURBS:

- 7.1 APPLY BONDING AGENT:** Apply modified thin-set using 1/4" x 3/8" x 1/4" square-notched trowel over the substrate. Apply modified thin-set to the bottom and ends of the Noble Solid Curb(s).
- 7.2 EMBED CURBS:** Embed the Solid Curb(s) into the modified thin-set using firm pressure to ensure there is 100% coverage and no voids. Lay flat edge on Curb(s) to ensure they are aligned. Check Curb(s) to ensure they are flat and level.



## 8. INSTALL VALUESEAL ON BASE:

- 8.1 MEASURE AND CUT:** Measure the shower floor, adding 2" for each upturn onto walls and Curbs. Cut ValueSeal to measurements. Fold and crease the sheet, then dry fit to the shower floor. Remove sheet.  
*NOTE: On 64" Base Kit, one 6' wide sheet of ValueSeal is provided for the shower pan. Trim and use excess for walls.*
- 8.2 APPLY BONDING AGENT:** Spread modified thin-set with the appropriate trowel to achieve coverage (e.g., 1/8" - 1/4" v-notch) onto base and upturns.
- 8.3 EMBED SHEET:** Use rubber hand roller or flat side of a trowel to embed ValueSeal into bond coat (flatten all ridges).  
*CAUTION: Be careful not to puncture membrane with corner of trowel.*



## 9. SECURE VALUESEAL TO DRAIN:

- 9.1 TEMPORARILY INSTALL CLAMPING COLLAR:** Align the clamping collar with the drain base under the membrane and press firmly to embed. Starting at one end, insert 5/8" screw through collar, piercing membrane, and into drain base. Install two screws on each end using a screw driver or low-torque cordless drill. **Do not over tighten.**
- 9.2 CUT AWAY VALUESEAL:** Cut away membrane from inside of the clamping collar. Remove the four 5/8" screws and clamping collar and set aside.
- 9.3 APPLY NOBLESEALANT:** Apply 1/4" continuous bead of NobleSealant under the ValueSeal and next to the chamfer on the drain base.
- 9.4 REINSTALL CLAMPING COLLAR:** Reattach the clamping collar to the drain base using all of the 5/8" screws.  
*NOTE: Some NobleSealant may squeeze out. Allow to dry and carefully peel away with a knife.*



**10. INSTALL THIN-LINE INSIDE CORNERS (4):**

- 10.1 **MARK AREA:** Mark the area where the Thin-Line Inside Corners will be applied.
- 10.2 **APPLY BONDING AGENT:** Spread modified thin-set to the marked area.
- 10.3 **EMBED THIN-LINE INSIDE CORNER:** Embed inside corners into modified thin-set using a margin trowel to ensure a quality seal.



**11. INSTALL VALUESEAL WATERPROOFING TO CURB:**

- 11.1 **MEASURE AND CUT:** Measure the length of the Curb. Cut a piece of ValueSeal to the measured length. Measure the height and width of the curb. Dry fit, then crease and cut ValueSeal to the necessary size, allowing excess to extend into the dry area. See Figure 2.
- 11.2 **APPLY BONDING AGENT:** Spread modified thin-set with the appropriate trowel to achieve coverage (e.g., 1/8" - 1/4" v-notch) onto the curb, overlapping the shower pan upturn 2".
- 11.3 **EMBED SHEET:** Use rubber hand roller or flat side of a trowel to embed ValueSeal into bond coat (flatten all ridges). Bond or trim off excess membrane in dry area as desired.

**FIGURE 2: MEASURE AND CUT CURB WATERPROOFING**

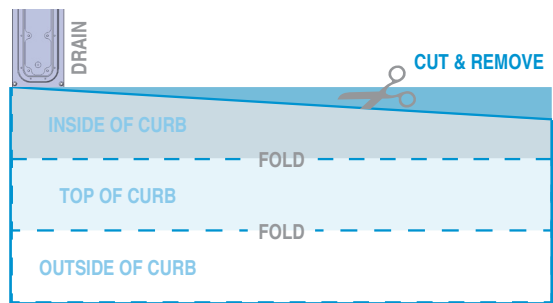

**12. INSTALL THIN-LINE OUTSIDE CORNERS (4):**

- 12.1 **MARK AREA:** Mark the area where the Thin-Line Outside Corners will be applied.
- 12.2 **APPLY BONDING AGENT:** Spread modified thin-set to the marked area.
- 12.3 **EMBED THIN-LINE OUTSIDE CORNER:** Embed outside corners into modified thin-set using a margin trowel to ensure a quality seal.



13. **PROTECTION OF SHEET:** After installation, sheet must be kept clean to enable tile adhesive to bond. If not covered by wearing surface, protect the installed sheet from damage and all foot traffic (use mortar skim coat, rugs, plywood, etc.).

14. **INSTALL VALUESEAL ON WALLS:**

- 14.1 **MEASURE AND CUT:** Measure the shower wall, adding 2" for each seam. Cut ValueSeal to measurements. Dry fit, then fold and crease the sheet.
- 14.2 **APPLY BONDING AGENT:** Spread modified thin-set with the appropriate trowel to achieve coverage (e.g., 1/8" - 1/4" v-notch) onto walls and seams.
- 14.3 **EMBED SHEET:** Use rubber hand roller or flat side of a trowel to embed ValueSeal into bond coat (flatten all ridges).  
**CAUTION:** Be careful not to puncture membrane with corner of trowel.



15. **INSTALL THIN-LINE PIPE COLLAR:**

- 15.1 **MARK AREA:** Mark the area where the Thin-Line Pipe Collar will be applied.
- 15.2 **APPLY BONDING AGENT:** Spread modified thin-set to the marked area.
- 15.3 **EMBED THIN-LINE PIPE COLLAR:** Embed collar into modified thin-set using a margin trowel to ensure a quality seal.

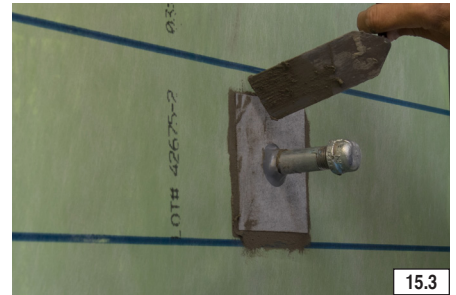
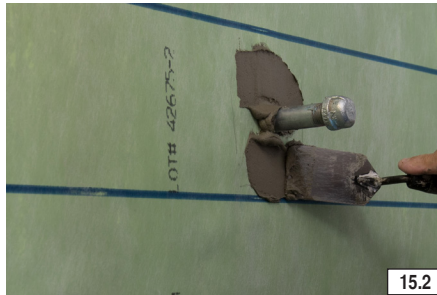
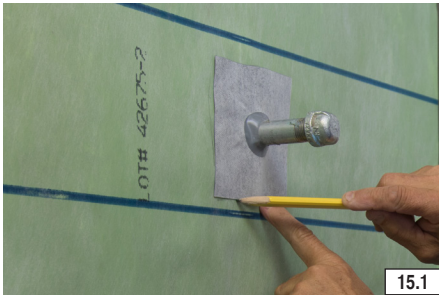

16. **INSTALL THIN-LINE MIXING VALVE COLLAR:**

- 16.1 **DRY FIT:** Dry fit collar over mixing valve, trim ID as needed.
- 16.2 **MARK AREA:** Mark the area where the Thin-Line Mixing Valve Collar will be applied.
- 16.3 **APPLY BONDING AGENT:** Spread modified thin-set to the marked area.
- 16.4 **EMBED THIN-LINE MIXING VALVE COLLAR:** Embed collar into modified thin-set using a margin trowel to ensure a quality seal.

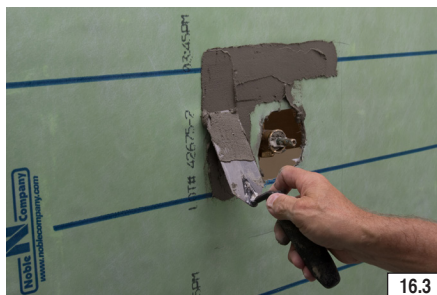

17. **FLOOD TESTING:** Allow sufficient time for curing, typically 24 hours. Flood test in accordance with local plumbing code requirements.

18. **COMPLETE FREESTYLE LINEAR DRAIN INSTALLATION:**

18.1 **INSTALL PRE-STRAINERS:** Place long leg of pre-strainer down, facing drain hole. Align strainer and install 1/2" pan head screw.

*NOTE: On all other drain lengths, place short leg of pre-strainer down, facing the drain hold.*

18.2 **INSTALL HEIGHT ADJUSTMENT SCREWS:** Screw in all 1-1/4" flat head height adjustment screws to approximately 3/8" above the clamping collar.

18.3 **TEMPORARILY ATTACH STRAINER:**

*NOTE: If using a Tile-Top strainer, refer to separate instruction sheet included with strainer.*

Place strainer over height adjustment screws. Temporarily fasten with 1" pan head screws. **Do not over tighten.**

*NOTE: Strainer attachment holes are not symmetrical. If screws do not align with holes in the drain base, turn the strainer.*



18.4 **TILE AND GROUT:** Protect the strainer with tape. Allow for a 1/16" clearance between the strainer and the tile. Tile and grout all surfaces in accordance with TCNA Handbook recommendations, ANSI A108 standards, and bond coat manufacturer's directions. Complete coverage of ValueSeal by the bond coat is required. Allow additional cure time (approximately 50%) when installed over ValueSeal.

*NOTE: If tiling with 2" x 2" or smaller tiles, use epoxy grout.*

18.5 **ADJUST HEIGHT ADJUSTMENT SCREWS:** Remove strainer. Remove tape from strainer. Place thin end of height adjustment tool on the tile and rest other end on height adjustment screws. Adjust the screws for level.

18.6 **REINSTALL STRAINER:** Place strainer over height adjustment screws. Confirm that strainer is flush with tile. Fasten three 1" pan head screws. **Do not over tighten.**

19. **CLEANING DRAIN:** To clean drain, remove 3 screws in top of strainer. Clear any hair or other obstructions from drain.

19.1 **RE-ATTACH STRAINER:** Place strainer over height adjustment screws. Replace all three screws. **Do not over-tighten.**

*NOTE: Strainer attachment holes are not symmetrical. If screws do not align with holes in drain base, turn the strainer.*

20. **LIMITATIONS:** This product is not designed for use as a wearing surface. ProBase II Base and Kit is not recommended for exterior applications. For applications or procedures not specifically detailed in these installation instructions, contact Noble Company. Wood subfloors must be clean, dry, and free of sealers, primers, and other substances that could affect bonding of the sheet to the base. ProBase II Base and Kit will not correct structural deficiencies. Deflection of the sub-floor must not exceed industry standards. Installation must follow TCNA recommendations and appropriate industry standards.

**For any applications or procedures not covered in these instructions, contact Noble Company.**

